

# CELLBOND-PHITEC Q-DUMMIES

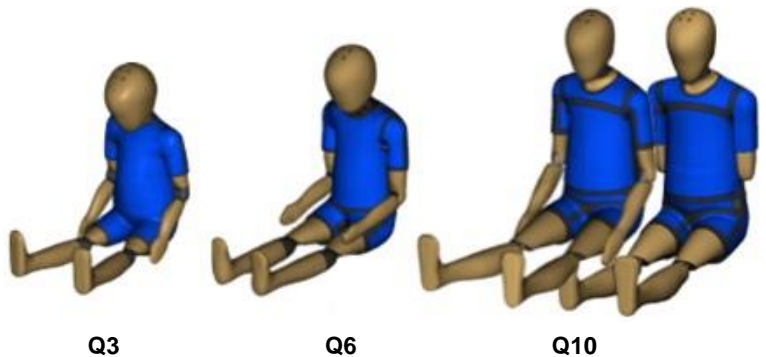









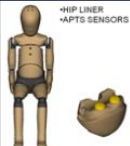

CELLBOND and PHITEC have an established partnership for the development of virtual models of the Q-Dummies family

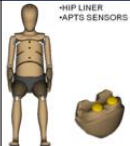
Q3, Q6 and Q10 dummy models are available today

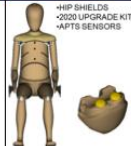
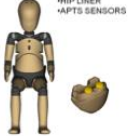

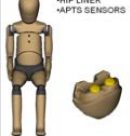
Q3, Q6 and Q10 models:

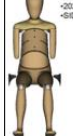
	Q3		Q6		Q10			
	R129	Euro NCAP	R129	Euro NCAP	R129	Euro NCAP	Euro NCAP 2020	C NCAP 2021
Front								
Side					No side impact testing in R129 with Q10			No side impact testing in C NCAP with Q10

## Model meshing details

The FE dummy models include all geometrical details. All the sensors are modeled as solid volumes

**S-Track** uses a kinematic mechanism to measure chest deflection. The model has a correct representation of mass and inertia

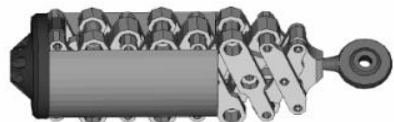

## Abdomen with APTS

The **Q10** model with **APTS** sensors for **C-NACP 2022** is now available

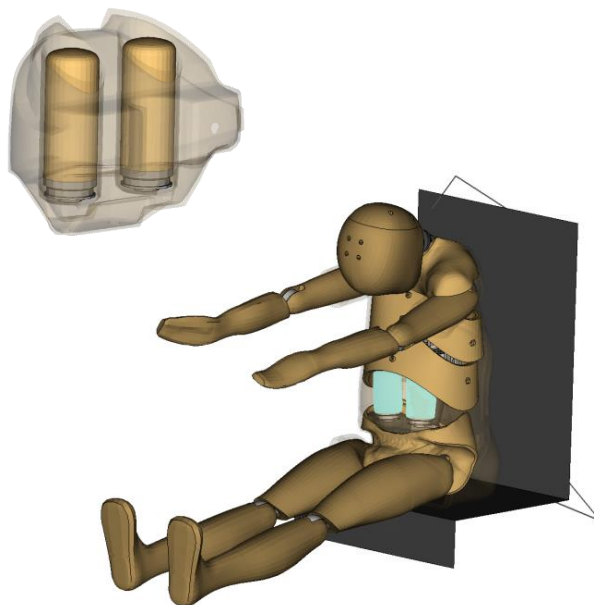

## Dummy Component Tests

The FE Model components have been validated with correlation tests at different impact speeds

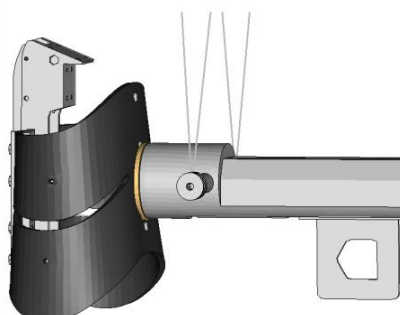
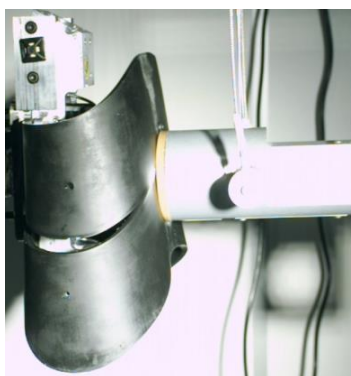

Physical test vs FE Model

## Software versions

The Q-dummies models are available for the LS-Dyna solver. The versions for Pam-Crash and RADIOSS solvers will be available upon request

## Easy dummy positioning

To make the dummy installation process as easy as possible, Phitec has established collaboration relationships with pre-processing tools editors such as Oasys for Primer, Beta CAE for Ansa and GNS for Generator 4

**For information and technical support please contact**

PHITEC INGEGNERIA SRL  
CORSO SUSA 299/A  
10098 RIVOLI (TO) ITALY  
tel. +39(0)119538090  
email: [atd@phitecingegneria.it](mailto:atd@phitecingegneria.it)  
[www.phitecingegneria.it](http://www.phitecingegneria.it)

### Our Distribution Partner:

CDH AG  
Despag-Straße 3  
85055 Ingolstadt, Germany  
email: [cdh@cdh-ag.com](mailto:cdh@cdh-ag.com)  
[www.cdh-ag.com](http://www.cdh-ag.com)

CDH-Japan Ltd.  
NISSO 13 Bldg. 3F  
2-5-1 Shin-Yokohama Kouhoku-ku  
Yokohama Kanagawa, 222-0033, Japan  
email: [customer\\_relation@cdh.co.jp](mailto:customer_relation@cdh.co.jp)